

TMN 300 DBR INOX

LEVEL MAGNETIC TRANSDUCERS

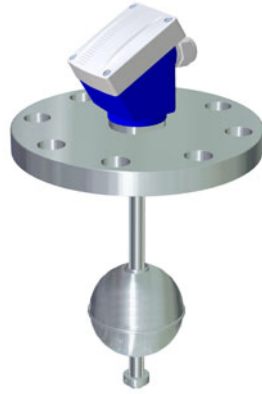

Operating principle When the float rises or falls by the guide tube due to the action of liquid is turned on or off a succession of reed contacts which generate an output proportional to the height of the level.

Character differential A single model allows connection systems 2, 3 or 4 wires.

Body	Process connection	DIN flange. DN100. SS AISI316 (1.4401)		
	Guide tube length (TG)	2500..5000 mm (Ø16 mm)		
	Standard height	E = 15 mm / S = 0 mm / LCP = 20 mm		
	Tube and stops	SS AISI316 (1.4401)		
	Temperature	-20..+100 °C		
	Protection	IP67		
Float	Model	Spherical Ø95x95 mm. SS AISI316L (FEI602B20)		
	Pressure	30 K/cm ²		
	Density	e < 0,45 g/cm ³		
	Temperature	-40..+125 °C		
	Dry zone (FS)	52,3 mm	Dimensions valid for a fluid density of 1 g/cm ³	
	Wet zone (FH)	42,7 mm		
Housing	Electrical connection	Connection housing PBT. 64 x 95 x 110 mm		
	Protection	IP67		
	Temperature (Ta)	-20..+80 °C		
	Cable gland	M20 x 1,5 (IP68)		
	Ø Electric hose	6..12 mm		
Output	Measurement level	4..20 mA		
	Measurement voltage	10..35 VDC		
	Repeatability	± 1%		
	Step between reads	10 mm. Optional 5 mm		
Supply	Supply voltage	2 wires	10..35 VDC	Terminal 3
		3 wires	735 - 10..35 VDC	Terminals 1-3
	4 wires	024 - 24 VAC	Terminals A1-A2	
		048 - 48 VAC		
110 - 110..125 VAC				
230 - 220..240 VAC				

Table 1: Process connection

Flange	DN100	
Ø t (mm)	8x18	
d (mm)	180	
Ø D (mm)	220	
Thickness LCP (mm)	20	

Dimensions

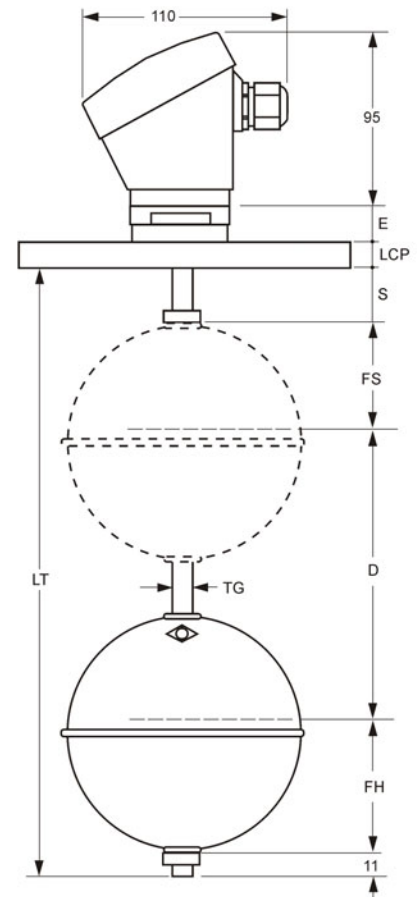

Legend

E	- Separation Process
S	- Zone unweighted
TL	- Total length
D	- Distance Measurement
TG	- Tube guide
FS	- Dry Float Zone
FH	- Wet Float Zone
LCP	- Height connection process

Connection and adjustment

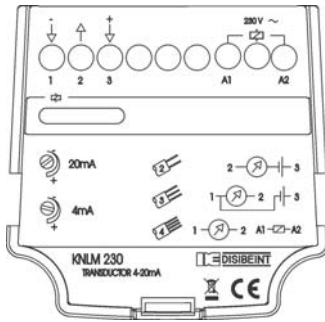

The sensor is factory preset for a reading of 4-20 mA between the margins (D). If you want to calibrate again, connect it as shown in the diagram. Place the float on the bottom and set 4 mA in the instrument by the multturn potentiometer [4mA]. Do the same with the potentiometer [20mA] placing the float on top.

Negative	1
Output mA	2
Positive	3
Supply AC	A1-A2

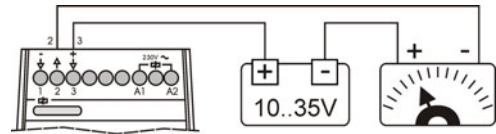

Load resistance in the loop (Converter)

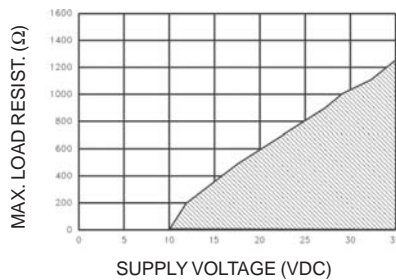

Supply in AC: The electronic circuit provides a voltage of 24 VDC to power the loop. The load resistor should not exceed 800 ohms.

Supply in DC: The maximum load resistance that can withstand the current loop is a function of supply voltage and not exceed the values shown in the accompanying graph.

Connexion examples

2 wires: Connect them to terminals 2 and 3 taking into account the polarity. A voltage source is required for supplying voltage to the current loop.

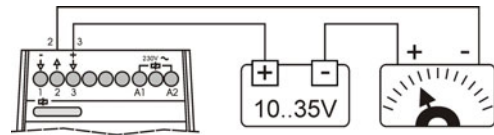

3 wires: Connect them to terminals 1, 2 and 3 taking into account the polarity. A voltage source is required for supplying voltage to the current loop.

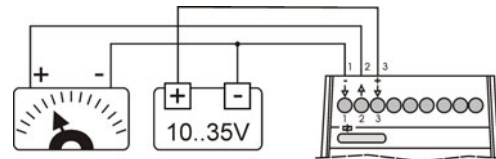

4 wires: The loop is connected to terminals 1 and 2 taking into account the polarity. The AC voltage is connected to terminals A1 and A2.

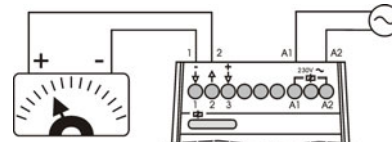

Assembly conditions

Handling

Do not use the housing to transport or to install the sensor in the tank. Once it is properly installed, you can rotate 350 degrees the head with the hand to place it in the adequate position.



Housing box orientable

Mounting position

The sensor must be mounted vertically. It should leave enough space on the vessel wall to prevent the float can touch it and avoid the proximity of magnetic or ferrous materials. We suggest to install the sensor away from the shaking elements, if any.

Electric cable

Use an appropriate cable for the electrical conditions in the facility. It is desirable that the cable gland closes entirely over the wire and it is essential in the course of environmental humidity or when be installed outdoors. In these cases, make a loop in the cable to facilitate the removal of accumulated drops (see figure).

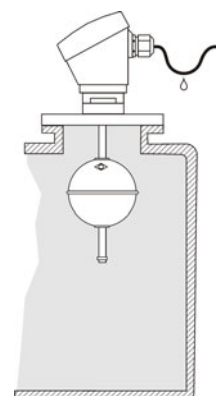

Maintenance

In some cases, depending on the medium to control and time spent, can be placed in the guide tube a layer of material which must be removed to avoid obstructing the movement of the float. To do this, proceed to clean and/or remove the sensor.

Recommendations and examples to place an order

Determine the resolution you want in your measurement by choosing the appropriate step between readings. A smaller distance between readings, the better resolution you get.

The resulting measures are a function of the density of the liquid and the float. Unless specified otherwise, the calculations are made based on the density of water, 1 g/cm³.

Note that the measurement can never be done from the bottom of the tank because there are some unavoidable levels resulting from the construction of the sensor itself, corresponding to the end of the guide tube and the height where it housed the buoyant level (see size chart on the first page for your understanding).

It is imperative that the sensor is manufactured to the maximum internal height of the tank as it can put the measurement distance where it suits you, taking into account the above. In any case, it is recommended that the total length of the sensor is somewhat lower than the maximum height inside the tank to prevent the tube is slightly curved and impede the movement of the float.

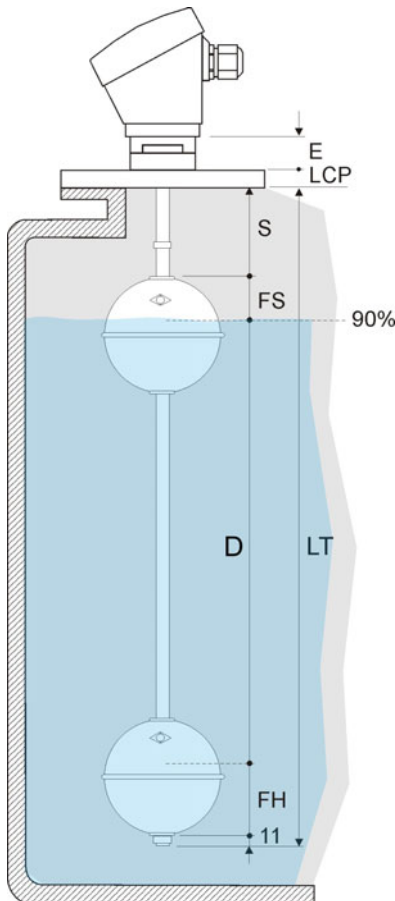

You can determine a bound (S) to establish an area where there is no reading at all. In case you want to remove the head of the connection process (for reasons of high temperature, for example) may specify a dimension (E) exceeding the standard.

To pass your order are essential the following information:

- Transition between readings,
- The length of the zone without measurement (S),
- The total length (TL)
- The supply voltage, if any
- The density of the liquid, if known and is different from 1 g/cm³

Example

In a tank of 1500 mm high skilled (LT) containing water to be measured up to 90% capacity. The distance from the bottom of the flange to the maximum fill elevation is 75 mm (S). You want a reading every 10 mm. Electrically connects to a link existing 4-20 mA (2 wire).

The data needed for their manufacture are:

- Step = 10 mm
- S = 75 mm
- LT = total length 1500 mm
- Without external supply
- Liquid density, if other than 1 g/cm³

Reference Composition		TMN 300 DBR INOX				<input type="checkbox"/>	R	<input type="checkbox"/>	LT	<input type="checkbox"/>	E	<input type="checkbox"/>	S	<input type="checkbox"/>
Supply voltage	2/3 wires	10..35 VDC	735											
		24 VAC	024											
	4 wires	48 VAC	048											
		110..125 VAC	110											
		220..240 VAC	230 *											
* Standard values		Step 5 mm	05											
		Step10 mm	10 *											
Dimensions E and S: If not specified, be construed as invalid.		Total length (LT)	(mm)											
		Distance (E)	(mm)											
		Distance (S)	(mm)											

To compose a reference, select an option from each of the columns.
Example: TMN 300 DBR INOX 230 P10 R10 LT1500 S75