

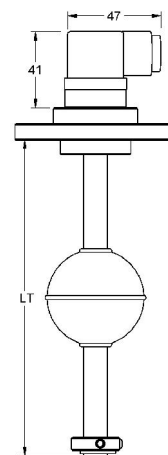



IMN BC INOX

MAGNETIC LEVEL SWITCH



General	Operating principle	The IMN level magnetic sensors are based on the action of a reed switch located inside the tube, which is activated by a magnet housed inside the float and moves due to the thrust of the liquid.	
	Application	<ul style="list-style-type: none"> · For the detection of one or more points in liquid level. · Used in maneuvers for filling, emptying, overflow alarm, etc. 	
	Fabrication	Are customized to suit the installation conditions.	
Housing	Electrical connection	DIN43650 connector	
	Protection	IP 65	
	Temperature (Ta)	-20..+90 °C	
	Cable gland	PG 9	
	Ø Electrical hose	6.8 mm	
Body	Guide tube and stops	SS AISI316 (1.4401). Ø12 mm	
	Length	90..3500 mm	
	Temperature	-40..+125 °C	
	Mounting position	Vertical, ±15°	
Process connection	Flange	BR80	
	Material	SS AISI316 (1.4401)	
	n x t (mm)	4x6	
	T (mm)	12	
	Ø d (mm)	65	
	D (mm)	80	
	Thickness (LCP) (mm)	8	
Floats	Model	FCI602M13	FEI601M13
	Material	SS AISI316L (1.4404)	
	Dimension (mm)	Ø 44x63	Ø 52x52
	Pressure (kg/cm ²)	15	30
	Density (g/cm ³)	e > 0,75	e > 0,76
	FS / FH (mm)	15,8 / 47,2	12,5 / 39,5
			
			
Contacts	Nr. of contacts	1..3	
	Class	NO: 120 WVA / 250 VAC-3A NC-NO/NC: 60 WVA / 230 VAC-1A	
	Distance between them	> 40 mm	
Protection	Standard	Normal execution without inner filling. Applicable to most applications.	
	Protected	Anti-condensation effect. In installations where there are large temperature differentials.	
	Insulated	Filled with epoxy resin. Establishing a higher degree of tightness.	

How to determine the sensor settings

Determine the total length according to the characteristics of the shell and the liquid level to be controlled.

According to the maneuver you wish to perform, determine the amount, location and type of contacts. Use the table below to define these characteristics.

Contacts: To set the type of contact (NO, NC, NONC) should be without the presence of the float. For example, if you want the lower end of the sensor contact opens when the tank runs out of fluid, seek an NC contact for the position.

Direction of action (↑ ↓): Set the direction of action of the float (the filling or emptying) allows more precise adjustment of the position of the contacts to the point of desired performance.

Electrical connection: If not otherwise specified explicitly, provide a common connection to all the contacts and an active connection for each of them, according to the diagram below.

Additional floats: The sensor comes equipped by default with a single float, the lower stop and if required, the upper stop. Can request as many additional floats as many contacts as necessary.

Conditions of work: Check that the conditions of pressure, temperature and density of your system match those offered by the model chosen. If you have questions regarding the behavior of materials in contact with the liquid you want to control, see chemical resistance chart on our website.

Apart from the possibilities listed here, there are others such as other floats, various electrical connections, etc. For any of these combinations refer to our document, "Connections and schema IMN" section in our website.

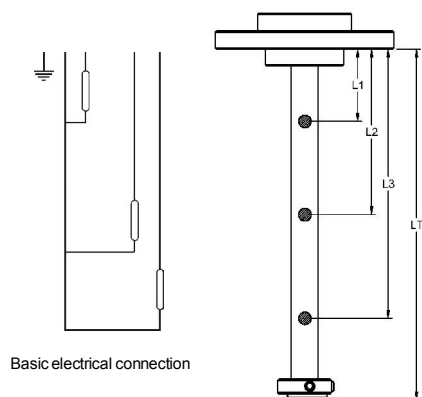

	mm	NO	NC	NONC	↑	↓	Stop
L1							
L2							
L3							
LT							

Use this document to define the data of sensor and attach it at the time of ordering. Specify in mm. total length of the sensor.

Specify in mm. the position of each of the contacts used in your application. Place an "X" the type and direction of action of each contact.

In the case of using additional floats, mark an "X" between what contacts should be placed caps separators. In the composition table references check boxes next to the selected features.

REFERENCE	VERSION	PROCESS	FLOAT	TOTAL LENGTH	Nr. CONTACTS	Nr. FLOATS
IMN BC INOX	<input type="checkbox"/> V1 Standard	<input type="checkbox"/> P42 BR80	<input type="checkbox"/> F14 FEI602M13	L 90..3500 mm	<input type="checkbox"/> C1 1 contact	<input type="checkbox"/> N1 1 float
	<input type="checkbox"/> V2 Protected		<input type="checkbox"/> F25 FCI601M13		<input type="checkbox"/> C2 2 contacts	<input type="checkbox"/> N2 2 floats
	<input type="checkbox"/> V3 Insulated				<input type="checkbox"/> C3 3 contacts	

To compose a reference, select an option from each of the columns. Example: IMN BC INOX V1 P42 F25 L500 C1 N1

Installations advise		Installation in areas with turbulence			
If the tank is metal walls, the probe will separate from them at least 100 mm.	The maximum slope should be ±15°	Place the sensor as far as possible from areas of turbulence.	Still pipe. Protects the race of the float of the turbulence.	Separating wall or discouragement.	PSIA, DSIA relay: Differential control of max. and min. by timing.

EXAMPLES TO ELECTRICAL CONNECTION

1 CONTACT

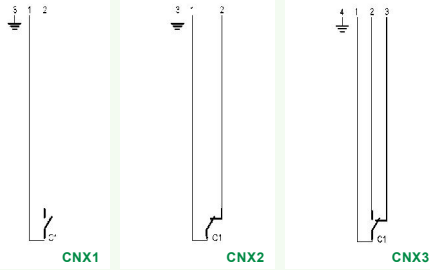

2 CONTACTS

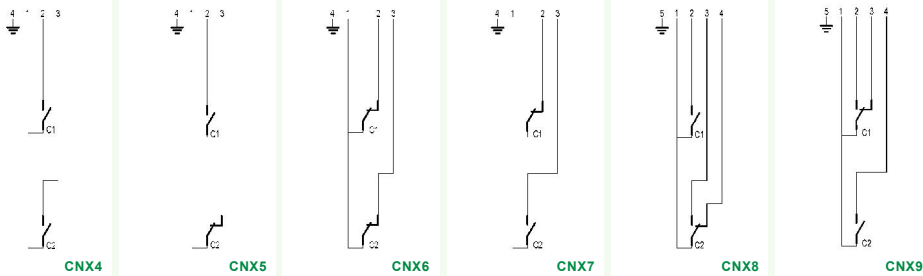

3 CONTACTS

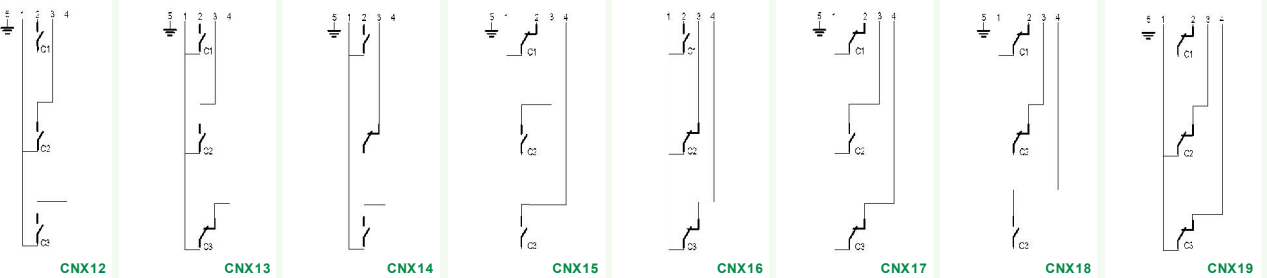

CONTROL OF ONE MAXIMUM OR MINIMUM LEVEL

1 CONTACT

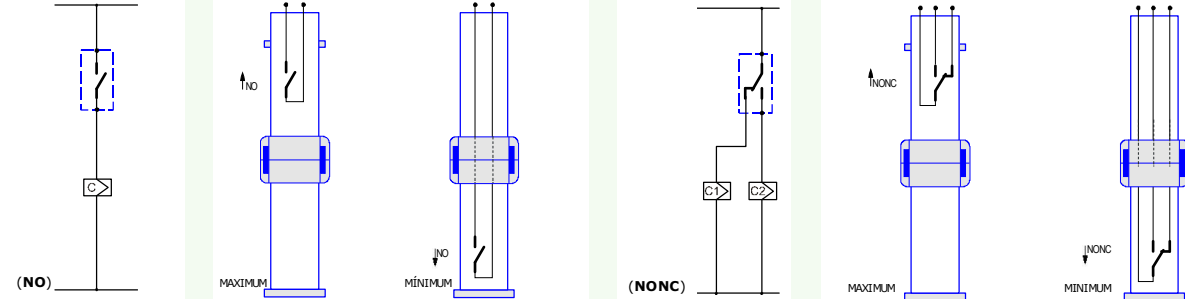

APPLICATION EXAMPLES
2 CONTACTS

START-STOP WITH INTERLOCKING

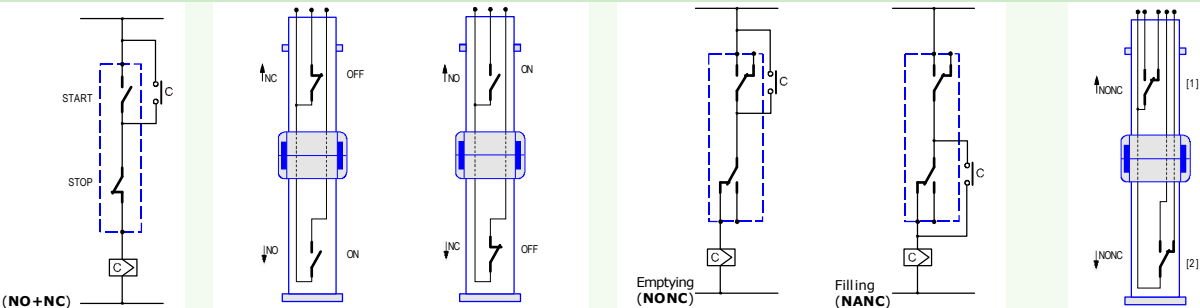

3 CONTACTS

START-STOP EMPTYING + ALARM TO LEVEL MINIMUM

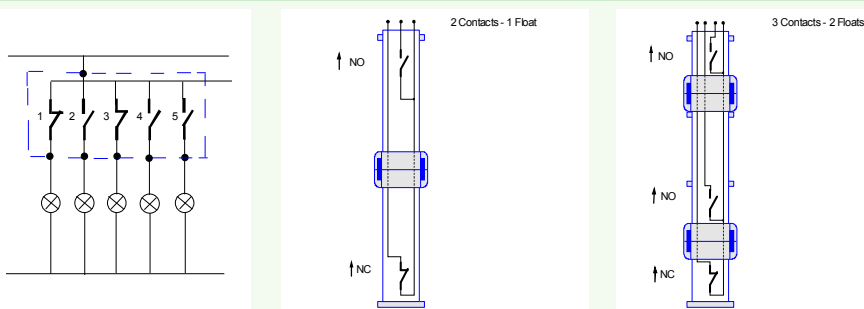

More information regarding in "Utilities/Tables" on our website (www.disibeint.com)